

目 录

一、运输作业组织与管理模块..... 2

二、仓储与配送作业组织与管理模块..... 34

三、国际物流作业组织与管理模块..... 150

| | |
|-----------------------|-----|
| 四、 快递物流作业组织与管理模块..... | 213 |
|-----------------------|-----|

湖南商务职业技术学院物流管理专业学生技能考核题库

一、运输作业组织与管理模块

○

○

○

| | | |
|--|--|--|
| | | |
|--|--|--|

○

○

| | | |
|--|--|--|
| | | |
| | | |
| | | |
| | | |
| | | |

| | | | | |
|--|--|--|--|--|
| | | | | |
|--|--|--|--|--|

| | | | | | |
|--|--|--|--|--|--|
| | | | | | |
| | | | | | |
| | | | | | |
| | | | | | |
| | | | | | |
| | | | | | |
| | | | | | |
| | | | | | |

() 任务描述

- :
-
-



| | | | | | | | | |
|---|--|--|--|---|--|---|--|--|
| | | | | | | | | |
| | | | | | | | | |
| | | | | | | | | |
| | | | | | | | | |
| | | | | | | | | |
| <input type="checkbox"/> <input type="checkbox"/> | | | | <input type="checkbox"/> <input type="checkbox"/> | | | | |
| <input type="checkbox"/> <input type="checkbox"/> | | | | | | | | |
| | | | | | | | | |
| | | | | | | <input type="checkbox"/> <input type="checkbox"/> <input type="checkbox"/> <input type="checkbox"/> | | |
| | | | | | | | | |
| | | | | | | | | |



| | | |
|--|--|--|
| | | |
| | | |
| | | |
| | | |
| | | |

| | | | | | |
|--|--|--|--|--|--|
| | | | | | |
| | | | | | |
| | | | | | |
| | | | | | |
| | | | | | |
| | | | | | |
| | | | | | |
| | | | | | |
| | | | | | |

() 任务描述:

-
-
-

| | | | | | | |
|--|--|--|--|--|--|--|
| | | | | | | |
| | | | | | | |
| | | | | | | |
| | | | | | | |
| | | | | | | |
| | | | | | | |
| | | | | | | |
| | | | | | | |
| | | | | | | |
| | | | | | | |
| | | | | | | |



| | | |
|--|--|--|
| | | |
| | | |
| | | |
| | | |
| | | |

| | | | | |
|--|--|--|--|--|
| | | | | |
| | | | | |
| | | | | |
| | | | | |

| | | | | |
|--|--|--|--|--|
| | | | | |
| | | | | |
| | | | | |
| | | | | |
| | | | | |
| | | | | |

| | | | | |
|--|--|--|--|--|
| | | | | |
| | | | | |
| | | | | |
| | | | | |
| | | | | |
| | | | | |
| | | | | |
| | | | | |
| | | | | |
| | | | | |
| | | | | |
| | | | | |

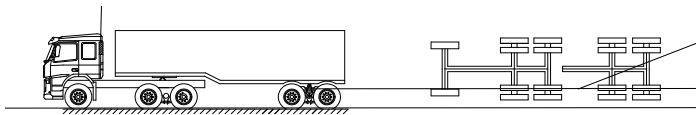

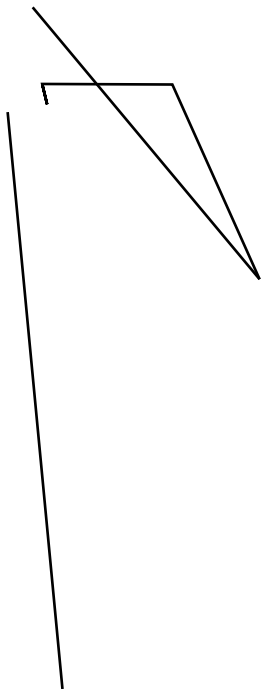
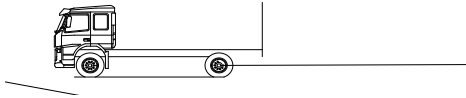
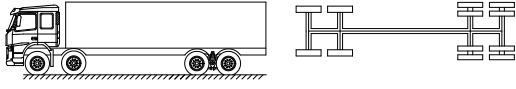
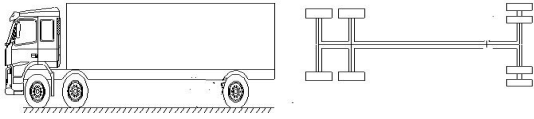

| | | | | | |
|--|--|--|--|--|--|
| | | | | | |
| | | | | | |
| | | | | | |
| | | | | | |
| | | | | | |
| | | | | | |
| | | | | | |
| | | | | | |

() 任务描述:

| | | |
|--|--|--|
| | | |
| | | |
| | | |
| | | |

| | | |
|--|--|--|
| | | |
| | | |
| | | |
| | | |

| | | |
|--|--|--|
| | | |
| | | |
| | | |
| | | |

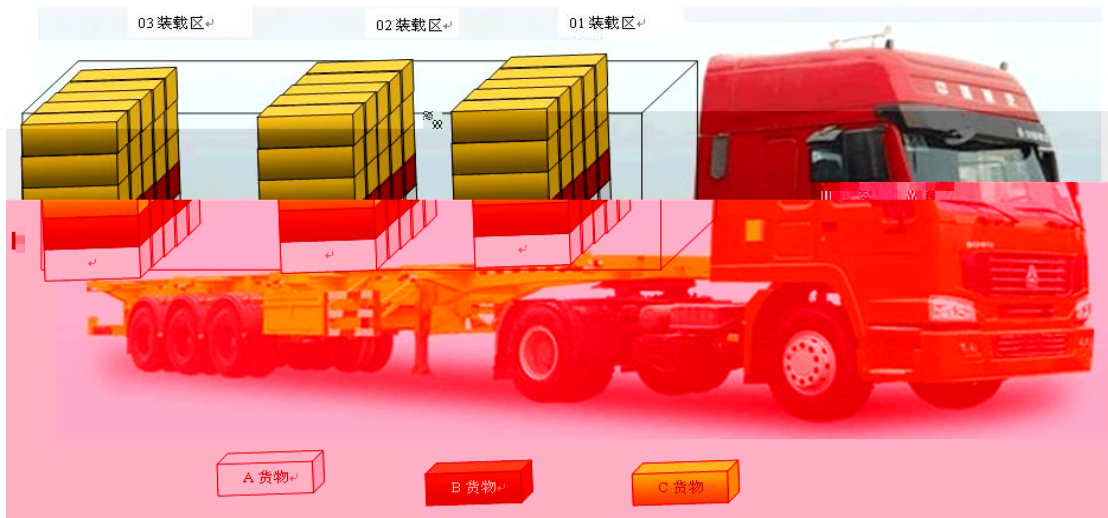

○

○

○

○

○

| | | |
|--|--|--|
| | | |
| | | |
| | | |
| | | |
| | | |

| | | | | |
|--|--|--|--|--|
| | | | | |
| | | | | |

| | | | | | |
|--|--|--|--|--|--|
| | | | | | |
| | | | | | |
| | | | | | |
| | | | | | |
| | | | | | |
| | | | | | |
| | | | | | |

() 任务描述



D

| | | | | | | | | | |
|---|--|--|---|--|--|---|--|--|--|
| | | | | | | | | | |
| | | | | | | | | | |
| | | | | | | | | | |
| | | | | | | | | | |
| | | | | | | | | | |
| <input type="checkbox"/> <input type="checkbox"/> | | | <input type="checkbox"/> <input type="checkbox"/> | | | | | | |
| <input type="checkbox"/> <input type="checkbox"/> | | | | | | | | | |
| | | | | | | <input type="checkbox"/> <input type="checkbox"/> <input type="checkbox"/> <input type="checkbox"/> | | | |
| | | | | | | | | | |
| | | | | | | | | | |



| | | | |
|---|--|--|--|
| | | | |
|  | | | |
|  | | | |
|  | | | |



2

| | | |
|--|--|--|
| | | |
| | | |
| | | |
| | | |
| | | |

3

4

| | | | | |
|--|--|--|--|--|
| | | | | |
| | | | | |

| | | | | | |
|--|--|--|--|--|--|
| | | | | | |
| | | | | | |
| | | | | | |
| | | | | | |
| | | | | | |
| | | | | | |
| | | | | | |

() 任务描述

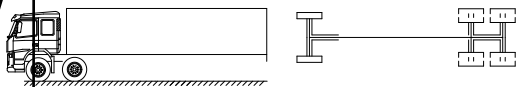
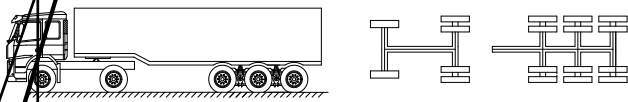
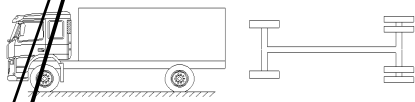
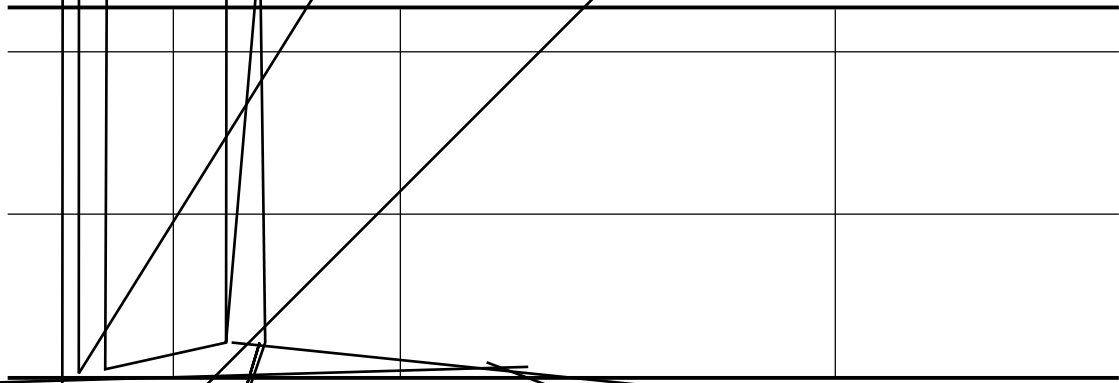



| | | |
|--|--|--|
| | | |
| | | |
| | | |
| | | |
| | | |

| | | | | |
|--|--|--|--|--|
| | | | | |
| | | | | |
| | | | | |
| | | | | |

| | | | | |
|--|--|--|--|--|
| | | | | |
| | | | | |
| | | | | |
| | | | | |
| | | | | |
| | | | | |

() 任务描述

-
-
-
-
-

| | | |
|--|--|--|
| | | |
| | | |
| | | |

| | | |
|--|--|--|
| | | |
| | | |
| | | |

| | | | | |
|--|--|--|--|--|
| | | | | |
| | | | | |
| | | | | |
| | | | | |
| | | | | |
| | | | | |

| | | | | | |
|--|--|--|--|--|--|
| | | | | | |
| | | | | | |
| | | | | | |

() 任务描述

()

()

| | | | | | |
|--|--|---|-----|--|--|
| | | | | | |
| | |) | () | | |
| | | | | | |

()

()

()

()

()

| | | |
|--|--|--|
| | | |
| | | |
| | | |
| | | |
| | | |
| | | |
| | | |
| | | |
| | | |

○

| | | | |
|-----|--|--|--|
| () | | | |
| | | | |
| | | | |
| | | | |
| | | | |
| | | | |
| | | | |
| | | | |
| | | | |
| | | | |
| | | | |
| | | | |

| | | | | | |
|--|--|--|--|--|--|
| | | | | | |
| | | | | | |
| | | | | | |
| | | | | | |
| | | | | | |
| | | | | | |
| | | | | | |
| | | | | | |
| | | | | | |
| | | | | | |
| | | | | | |
| | | | | | |
| | | | | | |
| | | | | | |
| | | | | | |

○

Sailing Schedule from : Shenzhen,Shenzhen,Guangdong,China

To : Los Angeles,Los Angeles,CA,United States

Origin City : Shenzhen,Shenzhen,Guangdong,China

CY/DOOR

Destination City : Los Angeles,Los Angeles,CA,United States

CY/DOOR

| 序列号 | 航线 | 船名 | 航次 | 截关时间 | 装货港 | 预计离港时间 | 实际离港时间 | 卸货港 |
|-----|------|-------------------|--------|------------------|---------|------------|--------|-------------|
| 1 | YPSW | YM UNISON | 59E | 2016-04-22 17:00 | Yantian | 2016-04-25 | | Los Angeles |
| 2 | SEA | NORTHERN JAVELIN | 002E | 2016-04-23 12:00 | Yantian | 2016-04-27 | | Long Beach |
| 3 | AAS2 | CMA CGM LIBRA | 095TXE | 2016-04-25 16:00 | Yantian | 2016-04-28 | | Long Beach |
| 4 | YPSW | YM UBIQUITY | 22E | 2016-04-29 17:00 | Yantian | 2016-05-02 | | Los Angeles |
| 5 | SEA | C SCL PUSAN | 117E | 2016-04-30 12:00 | Yantian | 2016-05-04 | | Long Beach |
| 6 | AAS2 | CMA CGM COLUMBA | 097TXE | 2016-05-02 16:00 | Yantian | 2016-05-05 | | Long Beach |
| 7 | SEA | COSCO NINGBO | 069W | 2016-05-06 11:00 | Yantian | 2016-05-08 | | Long Beach |
| 8 | YPSW | YM JIREBY... | 50E | 2016-05-06 17:00 | Yantian | 2016-05-09 | | Los Angeles |
| 9 | SEA | COSCO EXCELLENCE | 027E | 2016-05-07 12:00 | Yantian | 2016-05-11 | | Long Beach |
| 10 | AAS2 | CMA CGM CENTAURUS | 099TXE | 2016-05-09 16:00 | Yantian | 2016-05-12 | | Long Beach |
| 11 | YPSW | YM MASCULINITY | 32E | 2016-05-13 17:00 | Yantian | 2016-05-16 | | Los Angeles |
| 12 | SEA | HONG KONG BRIDGE | 039E | 2016-05-14 12:00 | Yantian | 2016-05-18 | | Long Beach |
| 13 | AAS2 | CMA CGM THALASSA | 101TXE | 2016-05-16 16:00 | Yantian | 2016-05-19 | | Long Beach |



干货箱



| | 箱体内部尺寸 | | | 箱体内容积及载重量 | | 箱门开度尺寸 | |
|-----|--------|------|------|-----------|--------------|--------|------|
| | L | W | H | Cu | P | W | H |
| 20' | 5898 | 2352 | 2393 | 33.2 | 21740/28230# | 2340 | 2280 |
| 40' | 12032 | 2352 | 2393 | 67.7 | 26630 | 2340 | 2280 |
| HC | 12032 | 2352 | 2698 | 76.3 | 26520 | 2340 | 2585 |

冷藏箱



| | 箱体内部尺寸 | | | 箱体内容积及载重量 | |
|-----|--------|------|------|-----------|--------------|
| | L | W | H | Cu | P |
| 20' | 5444 | 2284 | 2267 | 28.5 | 21135/27160# |
| 40' | 11583 | 2284 | 2250 | 58.7 | 26580 |
| HC | 11583 | 2284 | 2556 | 67.9 | 26380 |

开顶箱



| | 箱体内部尺寸 | | | 箱体内容积及载重量 | |
|-----|--------|------|------|-----------|-------|
| | L | W | P | Cu | P |
| 20' | 5900 | 2330 | 2337 | 32.6 | 21740 |
| 40' | 12025 | 2330 | 2337 | 65.8 | 26410 |

○

○

() 实施条件

| | | |
|--|--|--|
| | | |
| | | |
| | | |
| | | |
| | | |

() 考核时量

() 评分细则

1

| | | | | |
|--|--|--|--|--|
| | | | | |
| | | | | |
| | | | | |
| | | | | |
| | | | | |
| | | | | |
| | | | | |
| | | | | |

| | | | | | |
|--|--|--|--|--|--|
| | | | | | |
| | | | | | |

() 任务描述

| | | | | | | |
|--|--|--|--|--|--|--|
| | | | | | | |
| | | | | | | |



| | | | | | |
|--|--|--------------------------|--------------------------|--------------------------|--------------------------|
| | | | | | |
| | | | | | |
| | | | | | |
| | | <input type="checkbox"/> | <input type="checkbox"/> | <input type="checkbox"/> | <input type="checkbox"/> |
| | | | | | |

| | | | | | |
|--------------------------|--------------------------|--|--|--|--|
| | | | | | |
| | | | | | |
| | | | | | |
| <input type="checkbox"/> | <input type="checkbox"/> | | | | |
| <input type="checkbox"/> | <input type="checkbox"/> | | | | |
| | | | | | |
| | | | | | |

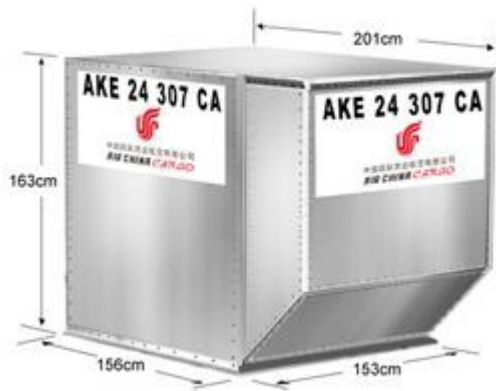

() 实施条件

| | | |
|--|--|--|
| | | |
| | | |
| | | |
| | | |
| | | |

() 考核时量

() 评分细则

| | | | | |
|--|--|--|--|--|
| | | | | |
| | | | | |
| | | | | |
| | | | | |

| | | | |
|--|--|--|--|
| | | | |
| | | | |



产品运输单

-
-
-
-
-
-
-
-

| | | |
|--|--|--|
| | | |
|--|--|--|

| | | |
|--|--|--|
| | | |
| | | |
| | | |
| | | |

| | | | | |
|----|--|--|--|--|
| | | | | |
| | | | | |
| | | | | |
| | | | | |
| 80 | | | | |
| | | | | |
| | | | | |
| | | | | |
| | | | | |

| | | | |
|--|--|--|--|
| | | | |
| | | | |
| | | | |
| | | | |
| | | | |
| | | | |
| | | | |
| | | | |
| | | | |
| | | | |
| | | | |
| | | | |
| | | | |
| | | | |
| | | | |

| | | | |
|--|--|--|--|
| | | | |
| | | | |



产品运输单

-
-
-
-
-
-
-
-

| | | | | | |
|--|--|--|--|--|--|
| | | | | | |
| | | | | | |
| | | | | | |
| | | | | | |
| | | | | | |
| | | | | | |
| | | | | | |
| | | | | | |
| | | | | | |
| | | | | | |

| | | | |
|--|--|--|--|
| | | | |
| | | | |
| | | | |
| | | | |
| | | | |
| | | | |
| | | | |
| | | | |
| | | | |
| | | | |
| | | | |
| | | | |
| | | | |
| | | | |
| | | | |

| | | | |
|--|--|--|--|
| | | | |
| | | | |



产品运输

-
-
-
-
-
-
-
-

| | | | | | |
|--|--|--|--|--|--|
| | | | | | |
| | | | | | |
| | | | | | |
| | | | | | |
| | | | | | |
| | | | | | |
| | | | | | |
| | | | | | |
| | | | | | |
| | | | | | |
| | | | | | |

| | | | |
|--|--|--|--|
| | | | |
| | | | |
| | | | |
| | | | |
| | | | |
| | | | |
| | | | |
| | | | |
| | | | |
| | | | |
| | | | |

| | | | |
|--|--|--|--|
| | | | |
| | | | |

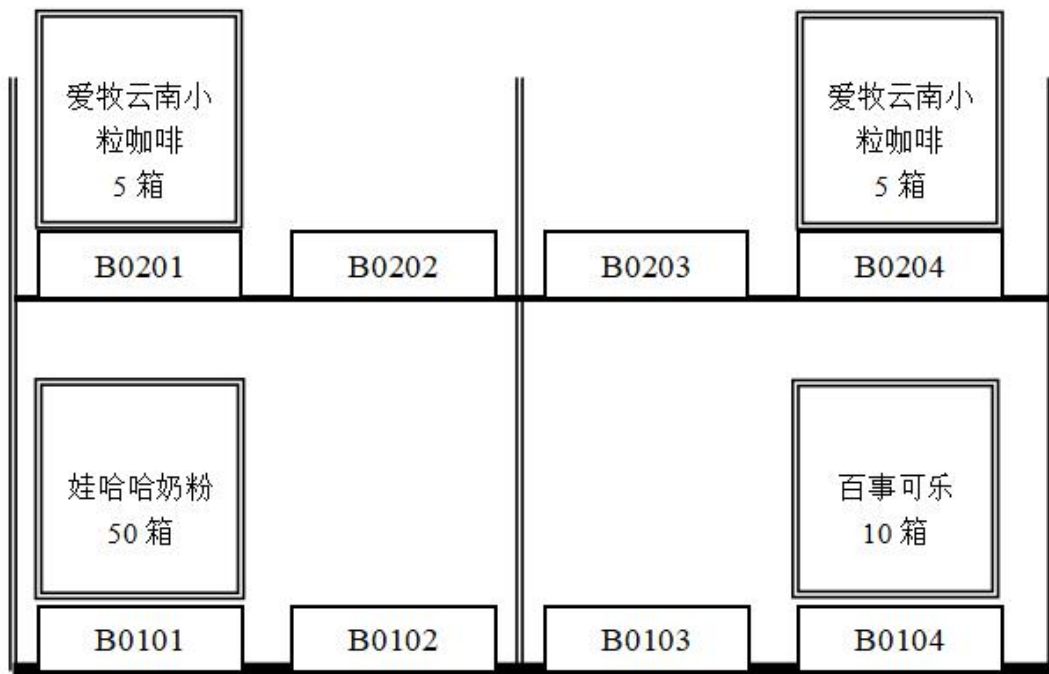

产品运输单

-
-
-
-
-
-
-
-

| | | |
|--|--|--|
| | | |
| | | |
| | | |

| | | | | | |
|--|--|--|--|--|--|
| | | | | | |
| | | | | | |
| | | | | | |
| | | | | | |
| | | | | | |
| | | | | | |
| | | | | | |
| | | | | | |
| | | | | | |
| | | | | | |
| | | | | | |
| | | | | | |
| | | | | | |
| | | | | | |

| | | | |
|--|--|--|--|
| | | | |
| | | | |
| | | | |
| | | | |
| | | | |
| | | | |
| | | | |
| | | | |
| | | | |
| | | | |
| | | | |
| | | | |
| | | | |

| | | | |
|--|--|--|--|
| | | | |
| | | | |



产品运输单

○

○

○

○

○

| | | | |
|--|--|--|--|
| | | | |
| | | | |
| | | | |
| | | | |



产品运输单

| | | | |
|--|--|--|--|
| | | | |
| | | | |
| | | | |
| | | | |
| | | | |
| | | | |
| | | | |
| | | | |
| | | | |
| | | | |
| | | | |
| | | | |

| | | | |
|--|--|--|--|
| | | | |
| | | | |



产品运输单

-
-
-
-
-
-
-
-
-

| | | |
|--|--|--|
| | | |
| | | |
| | | |

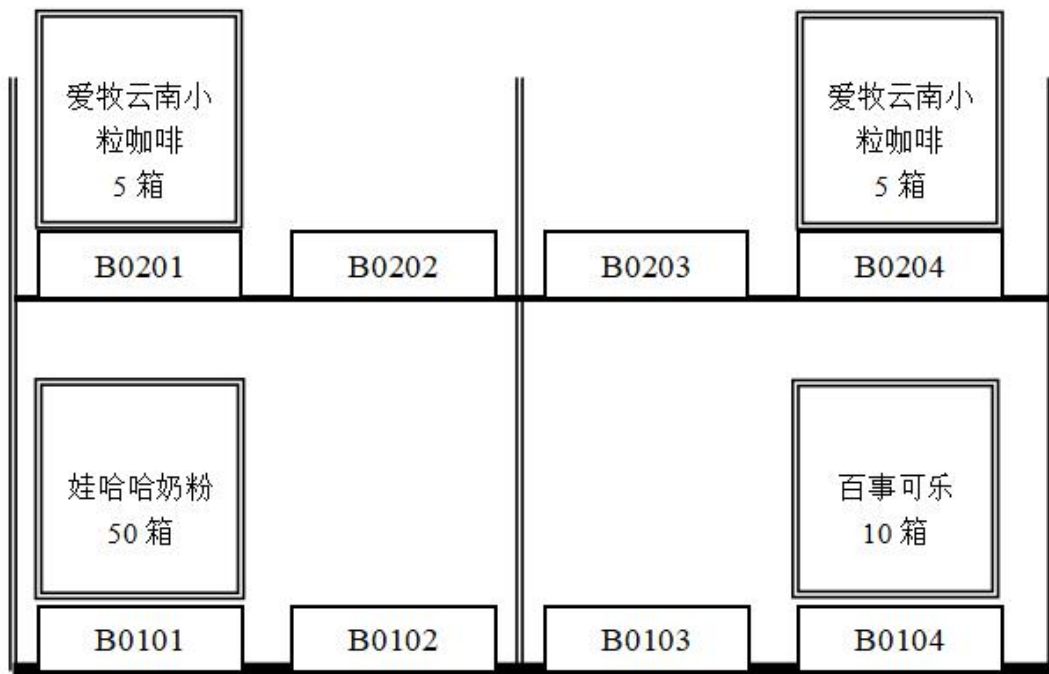

产品运输单

-
-
-
-
-
-
-
-

| | | | |
|--|--|--|--|
| | | | |
| | | | |
| | | | |
| | | | |
| | | | |
| | | | |
| | | | |
| | | | |
| | | | |
| | | | |
| | | | |
| | | | |
| | | | |
| | | | |
| | | | |

| | | | |
|--|--|--|--|
| | | | |
| | | | |

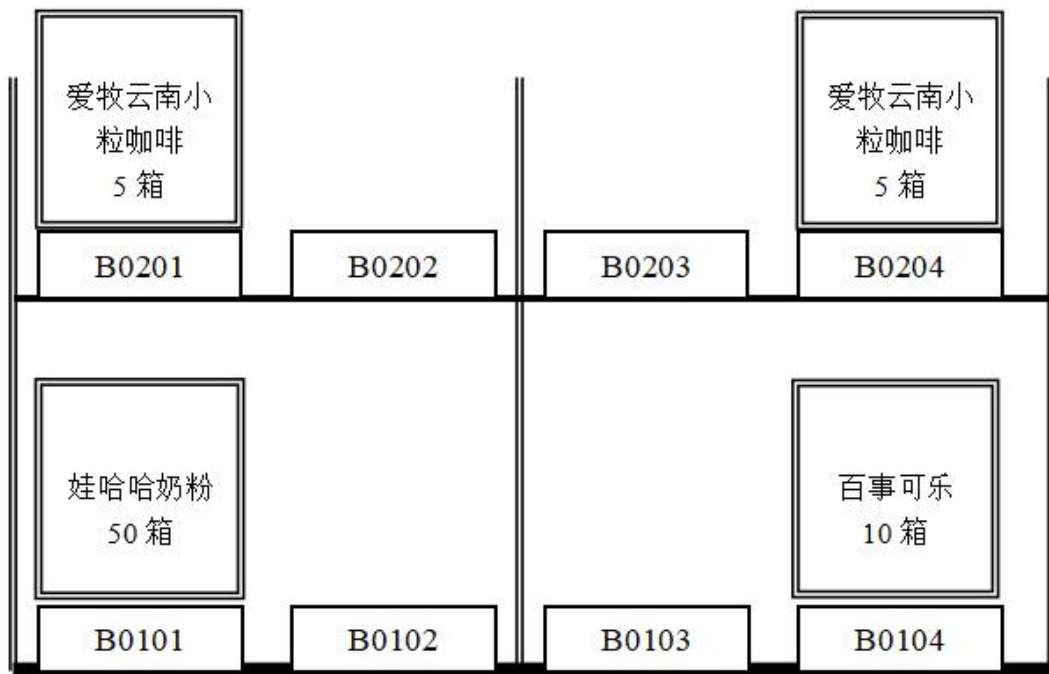

产品运输单

-
-
-
-
-
-
-
-



产品运输单

-
-
-
-
-
-
-
-

| | | |
|--|--|--|
| | | |
| | | |
| | | |

| | | | | | |
|--|--|--|--|--|--|
| | | | | | |
| | | | | | |
| | | | | | |
| | | | | | |
| | | | | | |
| | | | | | |
| | | | | | |
| | | | | | |
| | | | | | |
| | | | | | |
| | | | | | |

○





| | | |
|--|--|--|
| | | |
| | | |

| | | | | | |
|--|--|--|--|--|--|
| | | | | | |
| | | | | | |
| | | | | | |
| | | | | | |
| | | | | | |
| | | | | | |

| | | | | | |
|--|--|--|--|--|--|
| | | | | | |
|--|--|--|--|--|--|

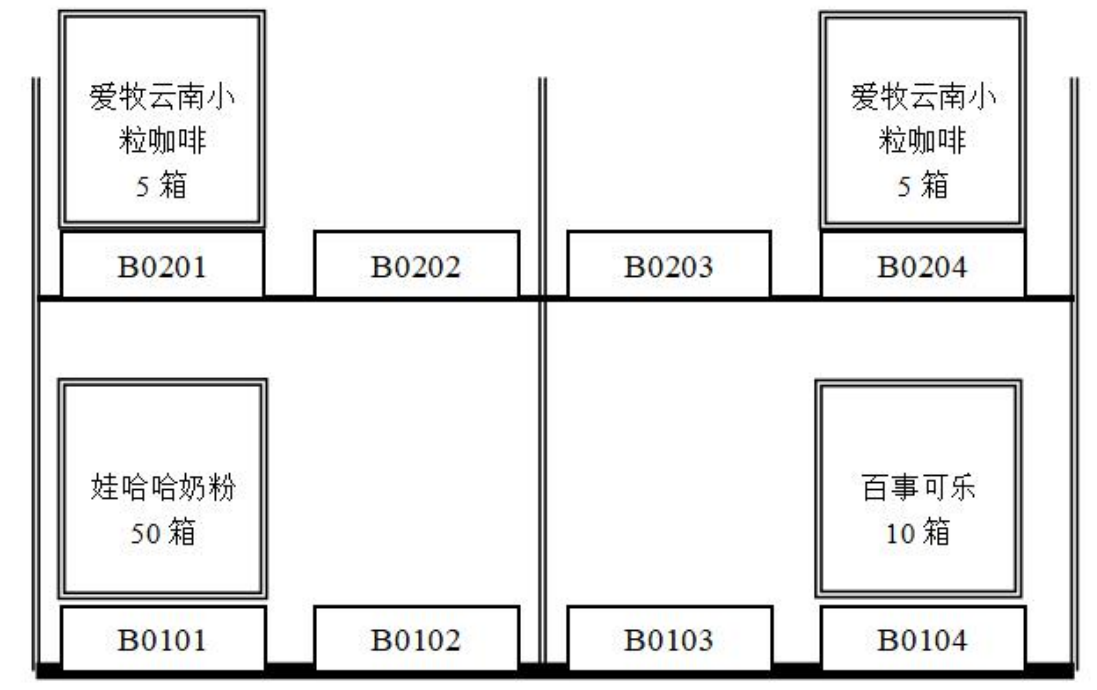

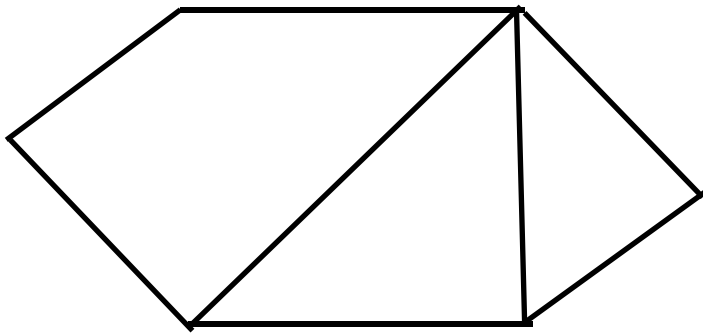

| | | | | |
|--|--|--|--|--|
| | | | | |
| | | | | |
| | | | | |
| | | | | |
| | | | | |
| | | | | |
| | | | | |





| | | | | | |
|--|--|--|--|--|--|
| | | | | | |
| | | | | | |
| | | | | | |
| | | | | | |
| | | | | | |
| | | | | | |
| | | | | | |
| | | | | | |

1

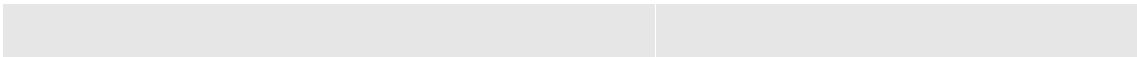



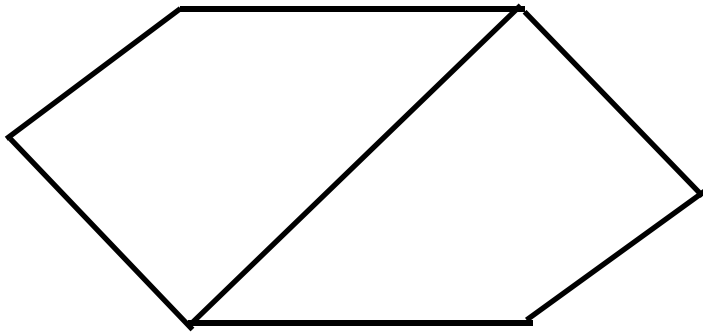

| | | |
|--|--|--|
| | | |
| | | |
| | | |

| | | | | |
|--|--|--|--|--|
| | | | | |
| | | | | |
| | | | | |
| | | | | |
| | | | | |
| | | | | |
| | | | | |
| | | | | |

| | | | | | |
|--|--|--|--|--|--|
| | | | | | |
| | | | | | |
| | | | | | |
| | | | | | |
| | | | | | |
| | | | | | |

1

| | | | | | |
|--|--|--|--|--|--|
| | | | | | |
| | | | | | |
| | | | | | |
| | | | | | |

| | | | | | |
|--|--|--|--|--|--|
| | | | | | |
|--|--|--|--|--|--|



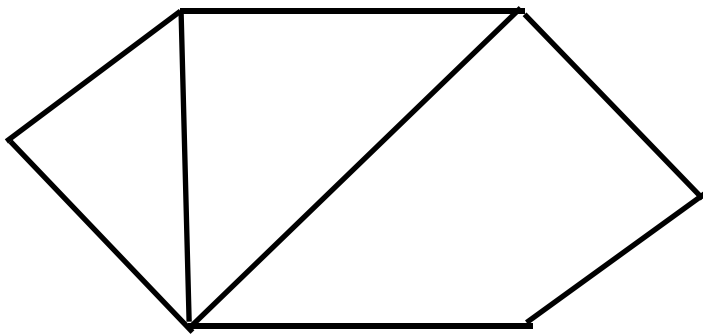

| | | | | |
|--|--|--|--|--|
| | | | | |
| | | | | |
| | | | | |
| | | | | |
| | | | | |
| | | | | |

| | | | | | |
|--|--|--|--|--|--|
| | | | | | |
| | | | | | |
| | | | | | |
| | | | | | |
| | | | | | |
| | | | | | |
| | | | | | |

| | | | | | | | | |
|--|--|--|--|--|--|--|--|--|
| | | | | | | | | |
| | | | | | | | | |
| | | | | | | | | |
| | | | | | | | | |
| | | | | | | | | |
| | | | | | | | | |
| | | | | | | | | |
| | | | | | | | | |
| | | | | | | | | |
| | | | | | | | | |
| | | | | | | | | |

| | | | | | | | |
|--|--|--|--|--|--|--|--|
| | | | | | | | |
| | | | | | | | |
| | | | | | | | |
| | | | | | | | |
| | | | | | | | |
| | | | | | | | |
| | | | | | | | |
| | | | | | | | |
| | | | | | | | |
| | | | | | | | |
| | | | | | | | |

| | | | | | | | |
|--|--|--|--|--|--|--|--|
| | | | | | | | |
| | | | | | | | |
| | | | | | | | |
| | | | | | | | |
| | | | | | | | |
| | | | | | | | |
| | | | | | | | |
| | | | | | | | |
| | | | | | | | |
| | | | | | | | |
| | | | | | | | |

○

| | | | |
|--|--|--|--|
| | | | |
| | | | |
| | | | |
| | | | |
| | | | |
| | | | |
| | | | |
| | | | |

○

| | |
|--|--|
| | |
| | |
| | |

| | |
|--|--|
| | |
| | |

| | | |
|--|--|--|
| | | |
| | | |
| | | |

| | | | | |
|--|--|--|--|--|
| | | | | |
| | | | | |
| | | | | |
| | | | | |
| | | | | |
| | | | | |
| | | | | |
| | | | | |
| | | | | |
| | | | | |

| | | | | | |
|--|--|--|--|--|--|
| | | | | | |
| | | | | | |
| | | | | | |
| | | | | | |

| | | | | | | |
|--|--|--|--|--|--|--|
| | | | | | | |
| | | | | | | |
| | | | | | | |
| | | | | | | |
| | | | | | | |
| | | | | | | |

| | | | | | | | | |
|--|--|--|--|--|--|--|--|--|
| | | | | | | | | |
| | | | | | | | | |
| | | | | | | | | |
| | | | | | | | | |
| | | | | | | | | |

| | | | | | | | | |
|--|--|--|--|--|--|--|--|--|
| | | | | | | | | |
| | | | | | | | | |
| | | | | | | | | |
| | | | | | | | | |
| | | | | | | | | |
| | | | | | | | | |
| | | | | | | | | |
| | | | | | | | | |
| | | | | | | | | |
| | | | | | | | | |
| | | | | | | | | |

| | | | | | | | |
|--|--|--|--|--|--|--|--|
| | | | | | | | |
| | | | | | | | |
| | | | | | | | |
| | | | | | | | |
| | | | | | | | |
| | | | | | | | |
| | | | | | | | |
| | | | | | | | |
| | | | | | | | |
| | | | | | | | |
| | | | | | | | |

| | | | | | | | |
|--|--|--|--|--|--|--|--|
| | | | | | | | |
| | | | | | | | |
| | | | | | | | |
| | | | | | | | |

○

| | | | |
|--|--|--|--|
| | | | |
| | | | |
| | | | |
| | | | |
| | | | |
| | | | |
| | | | |
| | | | |

○

| | |
|--|--|
| | |
| | |
| | |

| | |
|--|--|
| | |
| | |

| | | |
|--|--|--|
| | | |
| | | |
| | | |

| | | | | |
|--|--|--|--|--|
| | | | | |
| | | | | |
| | | | | |
| | | | | |
| | | | | |
| | | | | |
| | | | | |
| | | | | |
| | | | | |
| | | | | |
| | | | | |

| | | | | | |
|--|--|--|--|--|--|
| | | | | | |
| | | | | | |
| | | | | | |
| | | | | | |
| | | | | | |

| | | | | | | |
|--|--|--|--|--|--|--|
| | | | | | | |
| | | | | | | |
| | | | | | | |
| | | | | | | |
| | | | | | | |
| | | | | | | |
| | | | | | | |

| | | | | | | | |
|--|--|--|--|--|--|--|--|
| | | | | | | | |
| | | | | | | | |
| | | | | | | | |
| | | | | | | | |

| | | | | | | | | |
|--|--|--|--|--|--|--|--|--|
| | | | | | | | | |
| | | | | | | | | |
| | | | | | | | | |
| | | | | | | | | |
| | | | | | | | | |
| | | | | | | | | |
| | | | | | | | | |
| | | | | | | | | |
| | | | | | | | | |
| | | | | | | | | |
| | | | | | | | | |

| | | | | | | | |
|--|--|--|--|--|--|--|--|
| | | | | | | | |
| | | | | | | | |
| | | | | | | | |
| | | | | | | | |

○

| | | | |
|--|--|--|--|
| | | | |
| | | | |
| | | | |
| | | | |
| | | | |
| | | | |
| | | | |
| | | | |

○

| | |
|--|--|
| | |
| | |
| | |

| | |
|--|--|
| | |
| | |

| | | |
|--|--|--|
| | | |
| | | |
| | | |

| | | | | |
|--|--|--|--|--|
| | | | | |
| | | | | |
| | | | | |
| | | | | |
| | | | | |
| | | | | |
| | | | | |
| | | | | |
| | | | | |
| | | | | |
| | | | | |

| | | | | | |
|--|--|--|--|--|--|
| | | | | | |
| | | | | | |
| | | | | | |

| | | | | | | |
|--|--|--|--|--|--|--|
| | | | | | | |
| | | | | | | |
| | | | | | | |
| | | | | | | |
| | | | | | | |
| | | | | | | |
| | | | | | | |
| | | | | | | |
| | | | | | | |
| | | | | | | |
| | | | | | | |

| | | | | | | |
|--|--|--|--|--|--|--|
| | | | | | | |
| | | | | | | |

| | | | | | | |
|--|--|--|--|--|--|--|
| | | | | | | |
| | | | | | | |
| | | | | | | |
| | | | | | | |

○

| | | | |
|--|--|--|--|
| | | | |
| | | | |
| | | | |
| | | | |
| | | | |
| | | | |
| | | | |
| | | | |

○

| | |
|--|--|
| | |
|--|--|

| | |
|--|--|
| | |
| | |
| | |
| | |

| | | |
|--|--|--|
| | | |
| | | |
| | | |

| | | | | |
|--|--|--|--|--|
| | | | | |
| | | | | |
| | | | | |
| | | | | |
| | | | | |
| | | | | |
| | | | | |
| | | | | |
| | | | | |

| | | | | | |
|--|--|--|--|--|--|
| | | | | | |
| | | | | | |
| | | | | | |
| | | | | | |
| | | | | | |

| | | | | | |
|--|--|--|--|--|--|
| | | | | | |
| | | | | | |
| | | | | | |
| | | | | | |
| | | | | | |
| | | | | | |
| | | | | | |

| | | | | | | | |
|--|--|--|--|--|--|--|--|
| | | | | | | | |
| | | | | | | | |
| | | | | | | | |
| | | | | | | | |

| | | | | | | | |
|--|--|--|--|--|--|--|--|
| | | | | | | | |
| | | | | | | | |
| | | | | | | | |
| | | | | | | | |
| | | | | | | | |
| | | | | | | | |
| | | | | | | | |
| | | | | | | | |
| | | | | | | | |
| | | | | | | | |
| | | | | | | | |

○

| | | | |
|--|--|--|--|
| | | | |
| | | | |
| | | | |
| | | | |
| | | | |
| | | | |
| | | | |
| | | | |

○

| | |
|--|--|
| | |
| | |
| | |

| | |
|--|--|
| | |
| | |

| | | |
|--|--|--|
| | | |
| | | |

| | | | | | |
|--|--|--|--|--|--|
| | | | | | |
| | | | | | |
| | | | | | |

三、国际物流作业组织与管理模块

| | | |
|--|--|--|
| | | |
| | | |
| | | |
| | | |
| | | |

| | | | | |
|--|--|--|--|--|
| | | | | |
| | | | | |
| | | | | |

○

| | |
|--|--|
| | |
| | |
| | |
| | |

| | | |
|--|--|--|
| | | |
| | | |
| | | |
| | | |
| | | |

| | | |
|--|--|--|
| | | |
| |  | |
| | | |
| | | |
| | | |

| | | | | |
|--|--|--|--|--|
| | | | | |
| | | | | |
| | | | | |



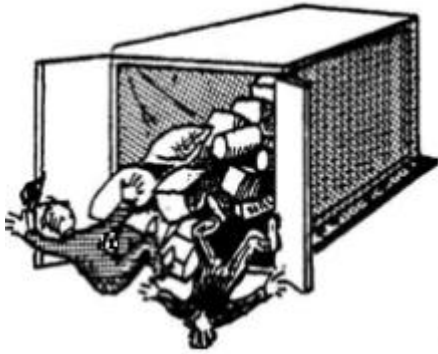
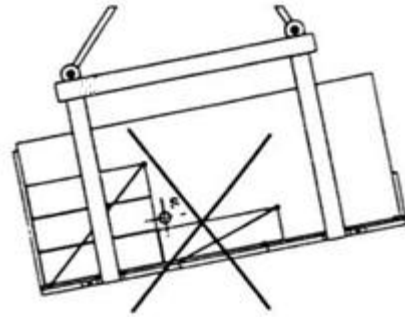

| | | |
|--|--|--|
| | | |
| | | |
| | | |
| | | |
| | | |

| | | | | |
|--|--|--|--|--|
| | | | | |
| | | | | |
| | | | | |
| | | | | |
| | | | | |
| | | | | |

| | | | | |
|--|--|--|--|--|
| | | | | |
| | | | | |
| | | | | |

○

| 船公司 Carrier | 船名/航次 Voyage | 服务代码 Service | 航线 Lane | 装船港/卸船港 Load/Unload Port | 启-达日期 ETD-ETA | 天 Day | 挂港 Port |
|--------------------|-----------------------------|--------------------------|-----------------|---------------------------------|--------------------|----------|------------|
| MSC 地中海航运 | MASTER 7408T | | 中国-香港台 | HONG KONG 香港 HACHSUNG 香港 | 02/25 (二) 03/15 | 18 | 香港 |
| NYK 日本邮船 | ITALIAN EXPRESS E 003 | | 中国-香港台 | HONG KONG 香港 BANGKOK 曼谷 | 02/25 (二) 03/02 | 8 | 香港 |
| CMA-CCM 中远船务 | CMA CCM GENONE 00A498 | | 中国-欧洲 | COAXEN 夏丁 DURBAN 德班 | 02/25 (二) 03/07 | 30 | 香港 |
| KLINE 基隆船务 | RYUNDAI PLATINUM M 004T | | 中国-中澳美 | SHANGHAI 上海 PAPANAGUA 巴帕那瓜 | 02/25 (二) 04/09 | 43 | 香港 |
| EMS 德忌利士 | COSSO KATHRYN S/00346E | | 中国-澳洲 | HONG KONG 香港 NOUMEA 努美阿 | 02/25 (二) 04/02 | 26 | 香港 |
| P&O 渣打船务 | RODA PERMASAN VPM114 | | 中国-中澳 波斯湾 印度 | QINGDAO 青岛 MADRAS 马德拉斯 | 02/25 (二) 03/18 | 18 | 香港 |
| ZIM 以星船务 | KUI HUNG 311 | CHINA_VIETN AM DYK | 中国-香港台 | NINGBO 宁波 HONG KONG 香港 | 02/25 (二) 03/15 | 18 | 香港 |
| SAPMARINE 比利时报航 | HEIRE P 1404 | | 中国-欧洲 | HACHSUNG 香港 MONTELO | 02/25 (二) 04/05 | 39 | 香港 |
| SEAN 长荣船务 | SAR SAN NICOLA S 01409 | | 中国-中澳美 | SHANGHAI 上海 RIO GRANDE 里奥格兰德 | 02/25 (二) 04/07 | 41 | 香港 |
| OOCL 东方海外 | OPREIDEN EXPRESS S 18808 | Pacific Atl antic FAX | 中国-澳洲 | SHANGHAI 上海 HALIFAX 哈利法克斯 | 02/25 (二) 04/14 | 48 | 香港 |

| | | |
|--|--|--|
| | | |
| | | |
| | | |
| | | |
| | | |

| | | | | |
|--|--|--|--|--|
| | | | | |
| | | | | |
| | | | | |
| | | | | |
| | | | | |
| | | | | |

| | | | | |
|--|--|--|--|--|
| | | | | |
| | | | | |
| | | | | |
| | | | | |

○
○

| BEIJING | CN | | BJ\$ |
|------------------------|------------|------------|---------------|
| Y. RENMINBI | CNY | | KGS |
| BOSTON | US | M | 630.00 |
| | | N | 79.97 |
| | | 45 | 60.16 |
| | | 100 | 53.19 |
| | | 300 | 45.80 |

| | | |
|--|--|--|
| | | |
| | | |
| | | |
| | | |
| | | |

| | | | | | |
|--|--|--|--|--|--|
| | | | | | |
| | | | | | |
| | | | | | |
| | | | | | |
| | | | | | |
| | | | | | |
| | | | | | |
| | | | | | |
| | | | | | |

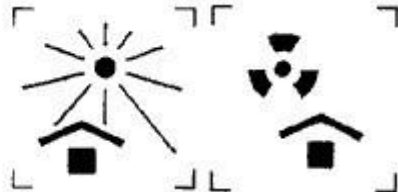

○

| | | |
|--|--|--|
| | | |
| | | |
| | | |
| | | |
| | | |

| | | | | |
|--|--|--|--|--|
| | | | | |
| | | | | |
| | | | | |
| | | | | |
| | | | | |
| | | | | |
| | | | | |

| | | | | | |
|--|--|--|--|--|--|
| | | | | | |
| | | | | | |
| | | | | | |

○

○

| | | | |
|--|--|--|--|
| | | | |
| | | | |

| | | |
|--|--|--|
| | | |
| | | |
| | | |
| | | |
| | | |

| | | | | |
|--|--|--|--|--|
| | | | | |
| | | | | |
| | | | | |
| | | | | |

| | | |
|--|--|--|
| | | |
| | | |
| | | |
| | | |
| | | |
| | | |
| | | |
| | | |
| | | |

**集装箱设备交接单
EQUIPMENT INTERCHANGE RECEIPT**

OUT 出场

No.

| | | | | | |
|---|--|---|---|---|-------------------------|
| 用箱人/运箱人(CNTR. USER/HAULIER) | | | 提箱地点(PLACE OF DELIVERY) | | |
| 发往地点(DELIVERED TO) | | | 返回/收箱地点(PLACE OF RETURN) | | |
| 船名/航次(VESSEL/VOYAGE No.) | 集装箱号(CNTR. No.) | 尺寸/类型(SIZE/TYPE) | 营运人(CNTR. OPTR) | | |
| 提单号(B/L No.) | 危险品类别(IMCO CLASS) | 箱封号(SEAL No.) | 免费期限(FREE TIME PERIOD) | 运载工具牌号(TRUCK WAGON BARGE No.) | |
| 货重(CARGO W.) | 出场目的/状态(PPS OF GATE-OUT/STATUS) | | 进场目的/状态(PPS OF GATE-IN/STATUS) | | 出场日期(TIME-OUT) 月 日 时 |
| 出场检查记录(INSPECTION AT THE TIME OF INTERCHANGE) | | | | | |
| 普通集装箱(GP. CNTR.) | 冷藏集装箱(RP. CNTR.) | 特种集装箱(SEL. CNTR.) | 发电机(GEN. SET) | | |
| <input type="checkbox"/> 正常(SOUND) <input type="checkbox"/> 异常(DEFFECTIVE) | <input type="checkbox"/> 正常(SOUND) 设定温度(SET) <input type="checkbox"/> 异常(DEFFECTIVE) 记录温度(RECORDED) | <input type="checkbox"/> 正常(SOUND) <input type="checkbox"/> 异常(DEFFECTIVE) | <input type="checkbox"/> 正常(SOUND) <input type="checkbox"/> 异常(DEFFECTIVE) | <input type="checkbox"/> 正常(SOUND) <input type="checkbox"/> 异常(DEFFECTIVE) | |
| 损坏记录及代号(DAMAGE CODE) | | | | | |



| | | |
|--|--|--|
| | | |
| | | |
| | | |
| | | |
| | | |

| | | | | |
|--|--|--|--|--|
| | | | | |
| | | | | |
| | | | | |
| | | | | |
| | | | | |
| | | | | |

| | | | | |
|--|--|--|--|--|
| | | | | |
| | | | | |

| | | |
|--|--|--|
| | | |
| | | |
| | | |

| | | |
|--|--|--|
| | | |
| | | |
| | | |

| | | | | |
|--|--|--|--|--|
| | | | | |
| | | | | |
| | | | | |
| | | | | |
| | | | | |
| | | | | |
| | | | | |
| | | | | |

| | | | | | |
|--|--|--|--|--|--|
| | | | | | |
|--|--|--|--|--|--|

| | | |
|--|--|--|
| | | |
| | | |
| | | |

| | | |
|--|--|--|
| | | |
| | | |

| | | | | |
|--|--|--|--|--|
| | | | | |
| | | | | |
| | | | | |
| | | | | |
| | | | | |
| | | | | |
| | | | | |
| | | | | |

| | | |
|--|--|--|
| | | |
| | | |
| | | |
| | | |
| | | |

| | | | | |
|--|--|--|--|--|
| | | | | |
| | | | | |
| | | | | |
| | | | | |
| | | | | |

| | | | | |
|--|--|--|--|--|
| | | | | |
| | | | | |
| | | | | |
| | | | | |

| | | |
|--|--|--|
| | | |
| | | |
| | | |
| | | |
| | | |

| | | | | |
|--|--|--|--|--|
| | | | | |
| | | | | |
| | | | | |

| |
|--|
| |
| |

| | | | | | | | |
|--|--|--|--|--|--|--|--|
| | | | | | | | |
| | | | | | | | |

| | | |
|--|--|--|
| | | |
|--|--|--|

| | | |
|--|--|--|
| | | |
| | | |
| | | |
| | | |

| | | | | |
|--|--|--|--|--|
| | | | | |
| | | | | |
| | | | | |
| | | | | |
| | | | | |
| | | | | |
| | | | | |
| | | | | |

| | | | | | |
|--|--|--|--|--|--|
| | | | | | |
|--|--|--|--|--|--|

| | | |
|--|--|--|
| | | |
| | | |

| | | |
|--|--|--|
| | | |
| | | |
| | | |
| | | |

| | | | | | |
|--|--|--|--|--|--|
| | | | | | |
|--|--|--|--|--|--|

| |
|--|
| |
| |

| | | | | | | | |
|--|--|--|--|--|--|--|--|
| | | | | | | | |
|--|--|--|--|--|--|--|--|

| | | | | | | | | |
|--|--|--|--|--|--|--|--|--|
| | | | | | | | | |
| | | | | | | | | |

○

| | | | | | |
|--|--|--|--|--|--|
| | | | | | |
| | | | | | |
| | | | | | |
| | | | | | |
| | | | | | |
| | | | | | |
| | | | | | |
| | | | | | |

| | | |
|--|--|--|
| | | |
| | | |
| | | |
| | | |
| | | |

| | | | | |
|--|--|--|--|--|
| | | | | |
| | | | | |
| | | | | |



| | | | |
|--|--|--|--|
| | | | |
| | | | |
| | | | |
| | | | |
| | | | |
| | | | |
| | | | |

| | | | | | |
|--|--|--|--|--|--|
| | | | | | |
| | | | | | |
| | | | | | |
| | | | | | |
| | | | | | |
| | | | | | |
| | | | | | |
| | | | | | |

Äc,,TD))PS" U"PQT 0c,,TD P 4ÿ

| | | |
|--|--|--|
| | | |
| | | |
| | | |
| | | |
| | | |

| | | |
|--|--|--|
| | | |
| | | |
| | | |
| | | |
| | | |

| | | | | |
|--|--|--|--|--|
| | | | | |
| | | | | |

○

| | | |
|--|--|--|
| | | |
| | | |
| | | |
| | | |
| | | |

| | | |
|--|--|--|
| | | |
|--|--|--|

| | | | | |
|--|--|--|--|--|
| | | | | |
| | | | | |
| | | | | |
| | | | | |
| | | | | |
| | | | | |
| | | | | |
| | | | | |

| | | |
|--|--|--|
| | | |
| | | |
| | | |
| | | |
| | | |

| | | | | |
|--|--|--|--|--|
| | | | | |
| | | | | |
| | | | | |
| | | | | |
| | | | | |
| | | | | |

| | | | | |
|--|--|--|--|--|
| | | | | |
| | | | | |
| | | | | |

| | | |
|--|--|--|
| | | |
| | | |

| | | |
|--|--|--|
| | | |
| | | |
| | | |

| | | | | |
|--|--|--|--|--|
| | | | | |
| | | | | |
| | | | | |
| | | | | |
| | | | | |
| | | | | |
| | | | | |
| | | | | |

| | | | | | |
|--|--|--|--|--|--|
| | | | | | |
|--|--|--|--|--|--|

○

○

○

| | | |
|--|--|--|
| | | |
| | | |
| | | |
| | | |
| | | |

○

| | | |
|--|--|--|
| | | |
| | | |
| | | |
| | | |
| | | |

| | | | | |
|--|--|--|--|--|
| | | | | |
| | | | | |
| | | | | |

| | | |
|--|--|--|
| | | |
| | | |
| | | |
| | | |
| | | |

| | | | | |
|--|--|--|--|--|
| | | | | |
| | | | | |
| | | | | |
| | | | | |

| | | | | |
|--|--|--|--|--|
| | | | | |
| | | | | |
| | | | | |
| | | | | |

四、 快递物流作业组织与管理模块

| | | |
|--|--|--|
| | | |
| | | |
| | | |

| | | |
|--|--|--|
| | | |
| | | |
| | | |

| | | |
|--|--|--|
| | | |
| | | |
| | | |

| | | |
|--|--|--|
| | | |
| | | |
| | | |

| | | |
|--|--|--|
| | | |
| | | |
| | | |

| | | |
|--|--|--|
| | | |
| | | |

| | | | | | |
|--|--|--|--|--|--|
| | | | | | |
|--|--|--|--|--|--|

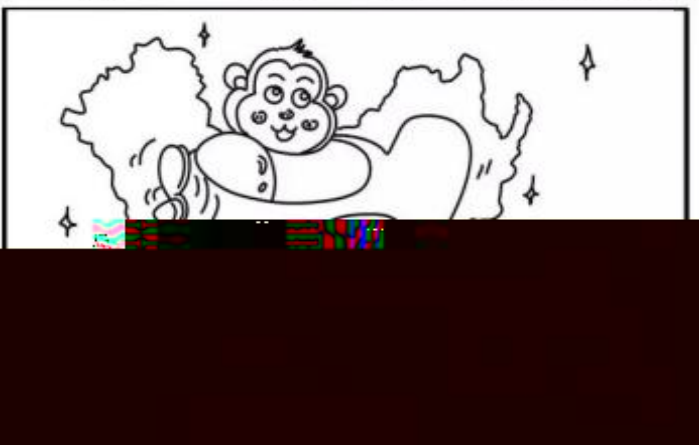
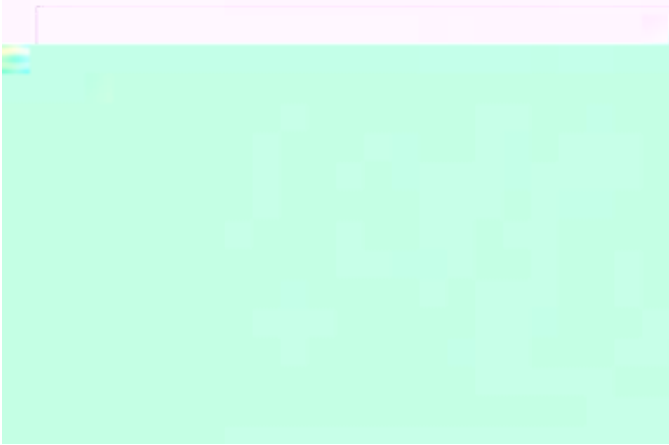
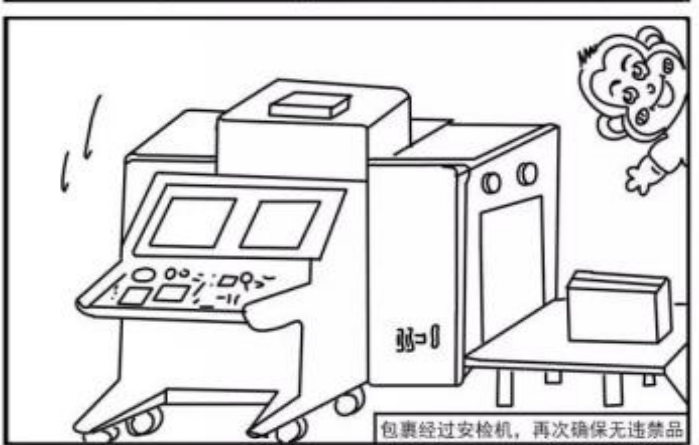
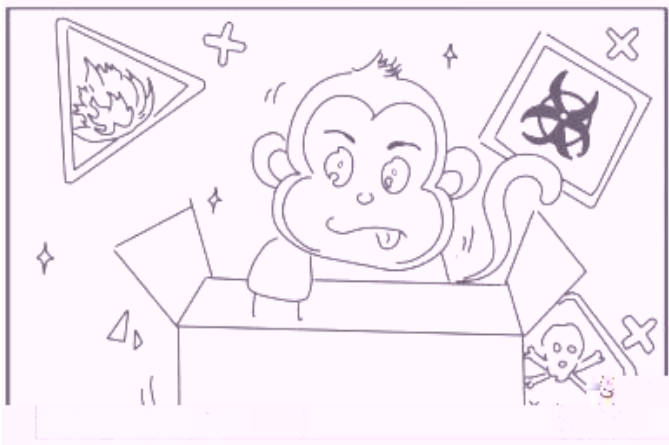

| | | |
|--|--|--|
| | | |
| | | |
| | | |

| | | |
|--|--|--|
| | | |
| | | |
| | | |
| | | |

| | | | | | |
|--|--|--|--|--|--|
| | | | | | |
|--|--|--|--|--|--|

ep

| | | |
|--|--|--|
| | | |
| | | |
| | | |

| | | |
|--|--|--|
| | | |
| | | |
| | | |
| | | |
| | | |

| | | |
|--|--|--|
| | | |
| | | |
| | | |

| | | |
|--|--|--|
| | | |
| | | |
| | | |
| | | |
| | | |

| | | |
|--|--|--|
| | | |
| | | |
| | | |

| | | |
|--|--|--|
| | | |
| | | |

| | | | | | |
|--|--|--|--|--|--|
| | | | | | |
|--|--|--|--|--|--|

[想知道:中国成都理工大学校园快递具体在哪? 百度知道](#)

3个回答 - 提问时间: 2014年02月10日

最佳答案:韵达在银杏后面。宝盒、圆通、顺丰在电影院后面。中通、申通在图书馆下面。常用的是这几个。

[zhidao.baidu.com/link?... 2014-02-15](#) - 百度快照 - 80%好评

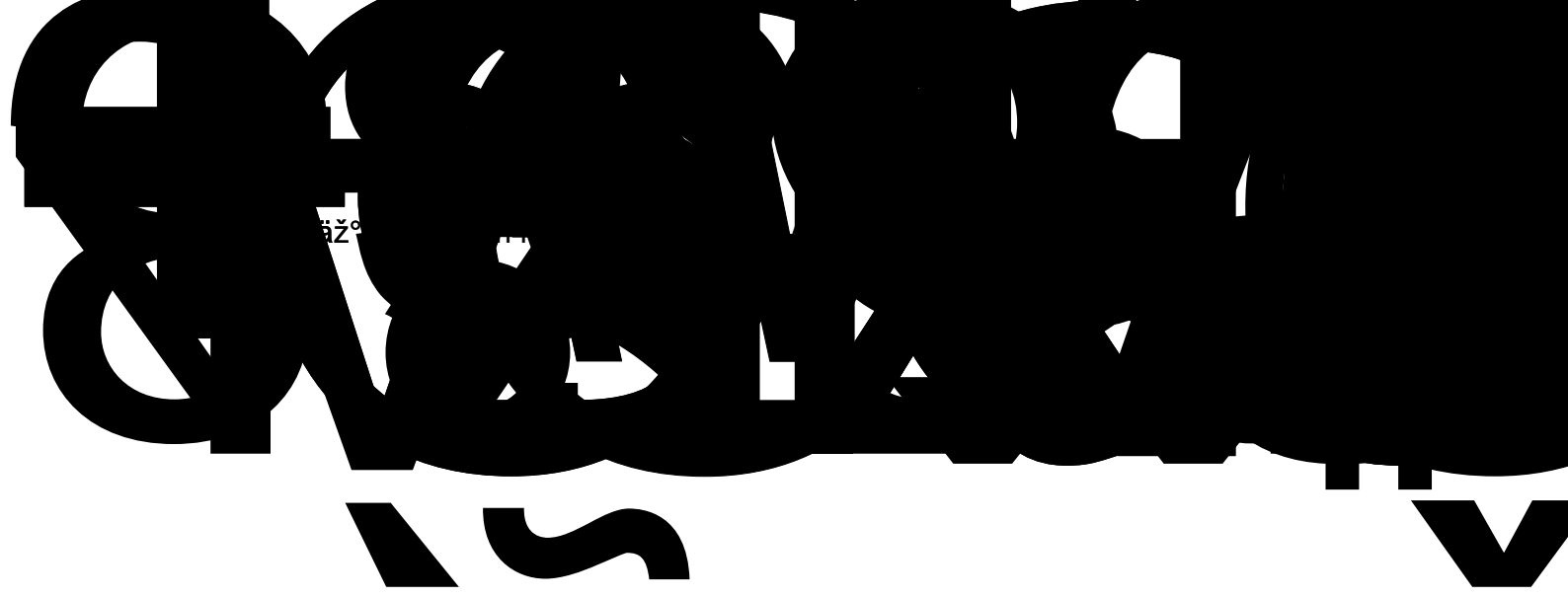

ž

| | | |
|--|--|--|
| | | |
| | | |
| | | |

| | | |
|--|--|--|
| | | |
| | | |
| | | |
| | | |
| | | |

| | | | | |
|--|--|--|--|--|
| | | | | |
| | | | | |
| | | | | |
| | | | | |
| | | | | |
| | | | | |
| | | | | |
| | | | | |

| | | | | | |
|--|--|--|--|--|--|
| | | | | | |
| | | | | | |
| | | | | | |

| | | |
|--|--|--|
| | | |
| | | |
| | | |

| | | |
|--|--|--|
| | | |
| | | |
| | | |
| | | |
| | | |

| | | | |
|--|--|--|--|
| | | | |
|--|--|--|--|

| | | |
|--|--|--|
| | | |
| | | |
| | | |
| | | |
| | | |

| | | |
|--|--|--|
| | | |
| | | |
| | | |
| | | |
| | | |

| | | |
|--|--|--|
| | | |
| | | |
| | | |
| | | |
| | | |

| | | | |
|--|--|--|--|
| | | | |
|--|--|--|--|

| | | |
|--|--|--|
| | | |
| | | |
| | | |
| | | |
| | | |



| | | |
|--|--|--|
| | | |
| | | |
| | | |
| | | |
| | | |

| | | | | |
|--|--|--|--|--|
| | | | | |
| | | | | |
| | | | | |

| | | | | | |
|--|--|--|--|--|--|
| | | | | | |
| | | | | | |
| | | | | | |
| | | | | | |

| | | |
|--|--|--|
| | | |
| | | |
| | | |
| | | |
| | | |

| | | | | | |
|--|--|--|--|--|--|
| | | | | | |
| | | | | | |
| | | | | | |
| | | | | | |
| | | | | | |

| | | |
|--|--|--|
| | | |
| | | |
| | | |
| | | |
| | | |

| | | | | |
|--|--|--|--|--|
| | | | | |
| | | | | |
| | | | | |
| | | | | |

| | | |
|--|--|--|
| | | |
| | | |
| | | |
| | | |
| | | |

| | | | | |
|--|--|--|--|--|
| | | | | |
| | | | | |
| | | | | |

| | | | | | |
|--|--|--|--|--|--|
| | | | | | |
| | | | | | |
| | | | | | |
| | | | | | |

| | | |
|--|--|--|
| | | |
| | | |
| | | |
| | | |
| | | |

| | | | | |
|--|--|--|--|--|
| | | | | |
| | | | | |
| | | | | |
| | | | | |
| | | | | |

| | | | | | |
|--|--|--|--|--|--|
| | | | | | |
| | | | | | |
| | | | | | |
| | | | | | |
| | | | | | |

| | | |
|--|--|--|
| | | |
| | | |
| | | |
| | | |
| | | |

| |
|-------|
| <hr/> |
|-------|

